

DATASHEET

15.6" AIO Android Touch Display

DP24J-15

Change Log

Ver.	Description	Edit	Review	Date
V2.0	Initial version			2024.02.04

Disclaimer

Version declaration: This user manual, including but not limited to all information contained herein, is protected by copyright law. Without the permission of Shenzhen DataMax, any behavior such as forgery, copying, excerpting, translating, or distribution is prohibited.

Disclaimer: The ownership and intellectual property rights of the third-party product names or content mentioned in this user manual belong to the respective product or content owners and are protected by current intellectual property laws and international treaties

CATALOGUE

CHAPTER 1 OVERVIEW	3
1.1 SCOPE OF APPLICATION.....	3
1.2 CHIP INTRODUCTION	3
1.3 USING SCENES.....	3
CHAPTER 2 PRODUCT OVERVIEW	4
2.1 DIMENSION.....	4
2.2 PHOTO.....	4
CHAPTER 3 DATASHEET	5
CHAPTER 4 PCBA DESCRIPTION	7
4.1 PCB DIAGRAM	7
4.2 INTERFACE OVERVIEW.....	7
4.3 INTERFACE DEFINITION	8
01-USB 2.0 (2*4pin/ 2.0mm)	8
02-Binaural speaker (2*2pin/ 1.25mm)	8
03-Microphone (12pin/1.25 mm FPC)	9
04-RTC interface (2pin/ 1.25mm)	9
05-Debug (2*4pin/ 1.25mm).....	9
06-Uart (2*4pin/ 1.25mm).....	10
07-KEY/IR/LED (8pin/ 1.25mm)	10
08-RS485 (4pin/2.0mm)	10
09-CAN (3pin/2.0mm)	10
10-MIPI BL Light (4pin/2.0mm)	11
11-Power Supply of LVDS/MIPI (6pin/2.0 mm)	11
12-LVDS/MIPI data interface (30pin/2.0mm FPC 1.0)	11
13-SPI/IO interface (10pin/0.5mm)	12
14-TP/I2C (6pin/ 0.5mm FPC)	13
15-EDP (30pin/0.5mm FPC)	13
16-Camera MIPI (30pin/0.5mm).....	15
CHAPTER 5 PRECAUTION	16

Chapter 1 Overview

1.1 Scope of Application

DM24J is an All-in-One android touch display which supports far field voice and HD camera built-in. With a high frequency of up to 2.0GHz, this processor offers low power consumption and high performance. It is widely applicable in various industries such as industrial control, energy and power, smart healthcare, instrumentation, and security monitoring. Some examples include industrial control hosts, robotic devices, ARM PCs, edge computing, cloud servers, and intelligent NVRs. Furthermore, it supports multiple operating systems including Android, Ubuntu, Debian, Buildroot, and RTLinux.

1.2 Chip Introduction

- RK3568B2 supports almost full-format H.264 decoder by 4K@60fps, H.265 decoder by 4K@60fps, also support H.264/H.265 encoder by 1080p@60fps, high-quality JPEG encoder/decoder.
- The build-in NPU supports INT8/INT16/FP16/BFP16 hybrid operation. In addition, with its strong compatibility, network models based on a series of frameworks such as TensorFlow/MXNet/PyTorch/Caffe can be easily converted.
- RK3568B2 has high-performance external memory interface(DDR3/DDR3L/DDR4/LPDDR3/LPDDR4/LPDDR4X) capable of sustaining demanding memory bandwidths.

1.3 Using scenes



Chapter 2 Product Overview

2.1 Dimension

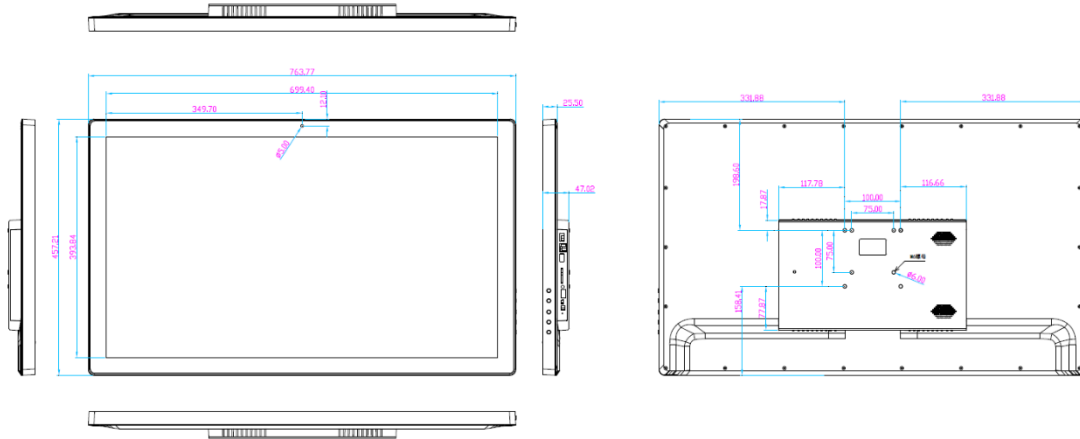

2.2 Photo

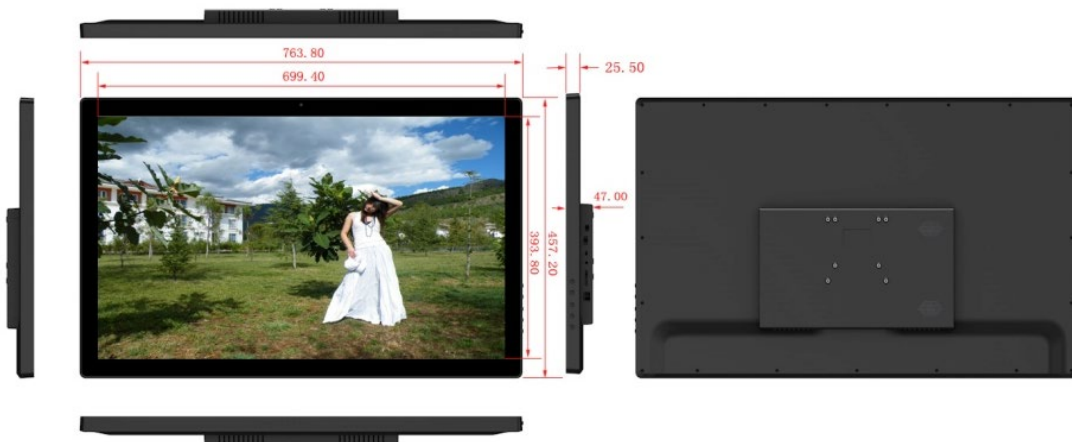

Chapter 3 Datasheet

LCD PANEL	
Brand	BOE NV156FHM-N42
Dimension	15.6"
Resolution	1920(H) * 1080(V)
EDP	2 Lanes
Aspect Ratio	16:9
Brightness (Typical)	220 cd/cm ²
Contrast (Typical)	800:1
Display Colors	6-bit color depth, display 262K colors
LED Life-time	15,000 hours (Define as the estimated time to 50% degradation of initial luminous)
View Angles L,R,UD (CR > 10)	85°/85°/85°/85°
Surface	Antiglare, Hard coating (3H)
VESA Dimension	100mm * 100mm , 75mm * 75mm
TOUCH SCREEN PANEL	
Touch Screen Type	Capacitive touch screen
Touch Panel Structure	GG, 10 points
TP Communication Interface	USB

PARAMETER		
SoC	RockChip RK3568B2 Quad-core ARM Cortex-A55 CPU up to 2.0GHz	
GPU	Mali-G52-2EE support OpenGL ES 1.1/2.0/3.2, OpenCL 2.0 and Vulkan 1.1	
NPU	1 TOP, support INT8/INT16/FP16/BFP16 hybrid operation, implement conversion of network model of TensorFlow / MXNet / PyTorch / Caffe series	
SYSTEM		
OS	Android	12 or above
	Linux	Ubuntu Desktop、Ubuntu Server、Debian11、Buildroot、RTLinux
VIDEO DECODER & ENCODER		
Video Encode	1080P@60fps - H.264/AVC BP/MP/HP@level4.2	
	1080P@60fps(4096x4096@10fps with TILE) - H.265/HEVC MP@level4.1	
Video Decode	4K@60fps - H.265 HEVC/MVC、4K@60fps - H.264 AVC/MVC、4K@60fps - VP9 Profile0/2	
	1080P@60fps - VP8 version2/VC1/MPEG-4/MPEG-2/MPEG-1	
HARDWARE & I/O		
Storage	DDR	2GB/4GB/8GB 64bit LPDDR4/LPDDR4x
	eMMC	16GB/32GB/64GB/128GB/256GB
	Extensions	1 × M.2 SATA3.0 (support extension of 2242 , 2242 NVME SSD) 1xM.2 USB 3.0(support extension of 5G / 4G LTE,NPU Extension
Network	LAN	1 × 1000M Ethernet (RJ45)
	WiFi	1 × 2.4GHz/5GHz dual band WiFi6, Bluetooth 5.2
	Data	1 × 4G LTE/5G (5G optional)

Output & Input	Video	1 × HD Camera (15MP max.) input 1 × AV video output 1 × HDMI output 2.0 (4K@60fps) , 1 × LVDS/MIPI output, 1 × EDP output
	Audio	1 × HDMI Audio output, 1 × Earphones output 2 × Mono Speaker Output (1 × Binaural speaker, 4Ω x 3W max.) 1 × Matrix Mic input
External Storage	USB interface	2 × USB 3.0, 1 × USB 3.0 (TYPE-C) , 2 × USB 2.0 (pin base)
	TF card	1 × TF Card (Up to 128GB)
Other Interfaces	IR sensor	1 × IR sensor
	RTC	1 × External RTC
	Extensions (pin base)	1 × Debug, 2 x Uart, 1 × CAN, 1 × RS485, 1 × SPI/IO, 1 × EDP, 1 × Camera MIPI, 1 × Key/IR/LED
Power Supply	Power	DC12V (5.5*2.1mm, optional 9V~18V, Voltage deviation ±5%)
	POE	Support power over ethernet (Output power is 30W)
Consumption	Standby	0.3W (12V/110mA)
	Average	4.8W (12V/400mA)
	Maximum	7W (12V/1700mA)
Environment	Working temp.	-20°C- 60°C
	Stored temp.	-20°C- 70°C
	Stored humidity	10%~ 90 %

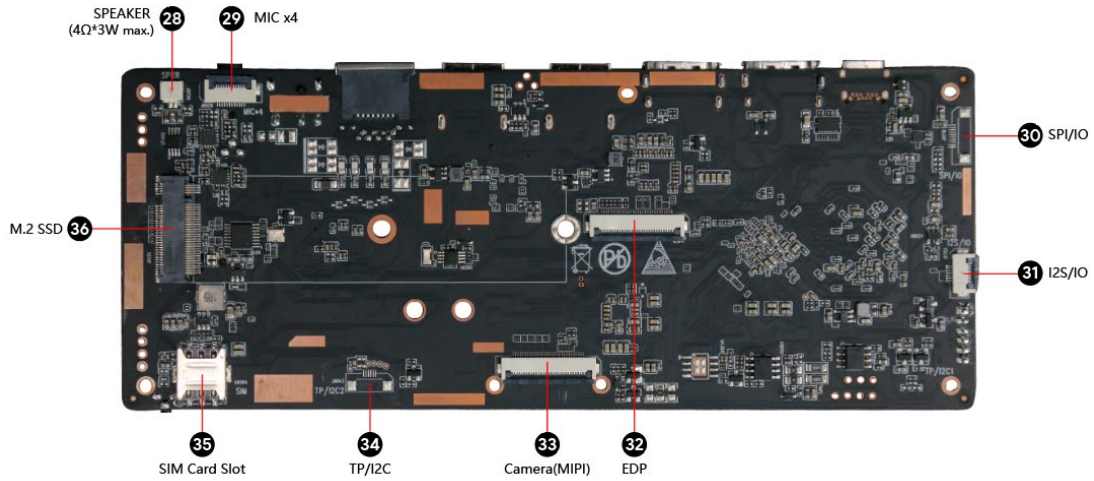

Declaration

The above photos are selected from a batch of boards produced by our company. Due to the continuous maintenance of the products, the boards actually shipped may not be consistent with the photos

4.3 Interface Definition

01-USB 2.0 (2*4pin/ 2.0mm)

No.	Definition	Parameter	Level/V	Location
1	5V	Power output, Limited Current 1A	5V	
2	DM	USB2.0 data -		
3	DP	USB2.0 data +		
4	GND	Ground		

02-Binaural speaker (2*2pin/ 1.25mm)

No.	Definition	Parameter	Level/V	Location
1	L-	Left channel-		
2	L+	Left channel+		
1	R-	Right channel-		
2	R+	Right channel+		

03-Microphone (12pin/1.25 mm FPC)

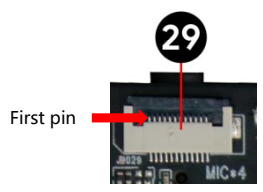
No.	Definition	Parameter	Level/V	Location
1	ACODEC1	Power output,	3.3V	
2	MIC1_INP	MIC input 1+	2.2V	
3	GND	Ground	0v	
4	ACODEC2	Power output,	3.3V	
5	MIC2_INP	MIC input 2+	2.2V	
6	GND	Ground	0v	
7	ACODEC3	Power output,	3.3V	
8	MIC3_INP	MIC input 3+	2.2V	
9	GND	Ground	0v	
10	ACODEC4	Power output,	3.3V	
11	MIC4_INP	MIC input 3+	2.2V	
12	GND	Ground	0v	

04-RTC interface (2pin/ 1.25mm)

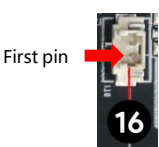
No.	Definition	Parameter	Level/V	Location
1	RTC_VCC	RTC power input	3V	
2	GND	Ground		

05-Debug (2*4pin/ 1.25mm)

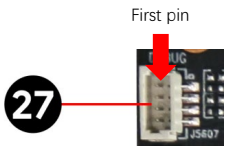
No.	Definition	Parameter	Level/V	Location
1	VCC3.3V	Power Output	3.3V	
2	UART-TX	Serial data output	3.3V	
3	UART-RX	Serial data input	3.3V	
4	GND	Ground	0V	

06-Uart (2*4pin/ 1.25mm)

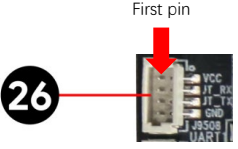
No.	Definition	Parameter	Level/V	Location
1	VCC3.3V	Power Output	3.3V	
2	UART-TX	Serial data output	3.3V	
3	UART-RX	Serial data input	3.3V	
4	GND	Ground	0V	

07-KEY/IR/LED (8pin/ 1.25mm)

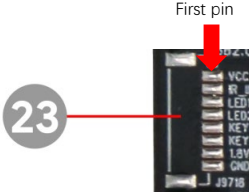
No.	Definition	Parameter	Level/V	Location
1	VCC3.3V	Power Output	3.3V	
2	IR_IN	IR_IN	3.3V	
3	LED1	IO LED1	3.3V	
4	LED2	IO LED2	3.3V	
5	KEY1	ADC KEY1	1.8V	
6	KEY2	ADC KEY2	1.8V	
7	1.8V	VCC	1.8V	
8	GND	Ground	0V	

08-RS485 (4pin/2.0mm)

Attention: Level of 485

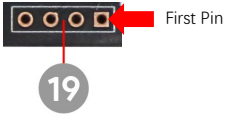
No.	Definition	Property	Level/V	Location
1	485 GND	GND	0V	
2	RS485 B-	RS485 B- Data		
3	RS485 B+	RS485 B+ Data		
4	485 GND	GND	0V	

09-CAN (3pin/2.0mm)

Attention: Level of CAN

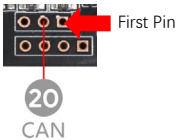
No.	Definition	Property	Level/V	Location
1	CAN H	CAN H Data		
2	CAN L	CAN L Data		
3	GNG	GNG	0V	

10-MIPI BL Light (4pin/2.0mm)

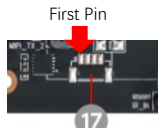
No.	Definition	Property	Level/V	Location
1	LED VCC+	LED VCC+ Power	30V	 <p>First Pin</p> <p>17</p> <p>MIPI BL LIGHT</p>
2	LED VCC+	LED VCC+ Power	30V	
3	LED VCC-	LED VCC- GND	0	
4	LED VCC-	LED VCC- GND	0	

11-Power Supply of LVDS/MIPI (6pin/2.0 mm)

No.	Definition	Parameter	Level/V	Location
1	LCD_12V	LCD power	12V	 <p>First pin</p> <p>22</p>
2	LCD_12V	LCD power	12V	
3	BL_EN	Backlight enabled	3.3V	
4	BL_PWM	Backlight control	3.3V	
5	GND	Ground	0	
6	GND	Ground	0	

12-LVDS/MIPI data interface (30pin/2.0mm FPC 1.0)

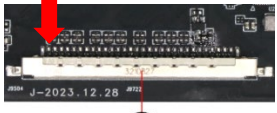
No.	Definition	Parameter	Level/V	Location
1	LVDS_D0N	Pixel0 Negative Data	1.2V	 <p>First pin</p> <p>18</p> <p>LVDS / MIPI data</p>
2	LVDS_D0P	Pixel0 Positive Data	1.2V	
3	LVDS_D1N	Pixel1 Negative Data	1.2V	
4	LVDS_D1P	Pixel1 Positive Data	1.2V	
5	LVDS_D2N	Pixel2 Negative Data	1.2V	
6	LVDS_D2P	Pixel2 Positive Data	1.2V	
7	GND	Ground	0V	
8	LVDS_CLKN	Negative Sampling Clock	1.2V	
9	LVDS_CLKP	Positive Sampling Clock	1.2V	
10	LVDS_D3N	Pixel3 Negative Data	1.2V	

11	LVDS_D3P	Pixel3 Positive Data	1.2V	
12	LVDS1_D0N	Pixel0 Negative Data	1.2V	
13	LVDS1_D0P	Pixel0 Positive Data	1.2V	
14	GND	Ground	0V	
15	LVDS1_D1N	Pixel1 Negative Data	1.2V	
16	LVDS1_D1P	Pixel1 Positive Data	1.2V	
17	GND	Ground	0V	
18	LVDS1_D2N	Pixel2 Negative Data	1.2V	
19	LVDS1_D2P	Pixel2 Positive Data	1.2V	
20	LVDS1_CLKN	Negative Sampling Clock	1.2V	
21	LVDS1_CLKP	Positive Sampling Clock	1.2V	
22	LVDS1_D3N	Pixel3 Negative Data	1.2V	
23	LVDS1_D3P	Pixel3 Positive Data	1.2V	
24	GND	Ground	0V	
25	LB_PWM	LB_PWM	3.3V	
26	LB_EN	LB_EN	3.3V	
27	-----	-----		
28	VCC12/5V	Optional Power	12V/5V/3.3V	
29	VCC12/5V	Optional Power	12V/5V/3.3V	
30	VCC12/5V	Optional Power	12V/5V/3.3V	

13-SPI/IO interface (10pin/0.5mm)

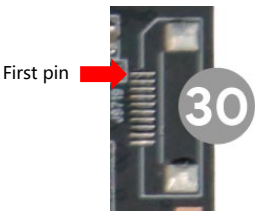
No.	Definition	Parameter	Level/V	Location
1	VCC1.8V	Power Output	1.8V	
2	VCC1.8V	Power Output	1.8V	
3	FSPI_D2/IO	FSPI_D2/IO	1.8V	
4	FSPI_CLK/IO	FSPI_CLK/GPIO	1.8V	
5	FSPI_D0/IO	FSPI_D0/GPIO	1.8V	
6	FSPI_D1/IO	FSPI_D1/GPIO	1.8V	

7	FSPI_CS0N/IO	FSPI_CS0N/GPIO	1.8V	
8	FSPI_D3/IO	FSPI_D3/GPIO	1.8V	
9	GND	Ground	0V	
10	GND	Ground	0V	

14-TP/I2C (6pin/ 0.5mm FPC)

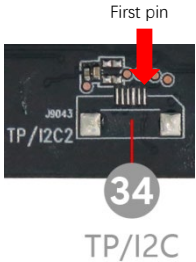
No.	Definition	Parameter	Level/V	Location
1	I2C_SCL_TP/IO	I2C1_SCL_TP/IO	3.3V	
2	I2C_SDA_TP/IO	I2C_SDA_TP/IO	3.3V	
3	GND	Ground	0V	
4	TP_RST/IO	TP_RST/IO	3.3V	
5	TP_INT/IO	TP_INT/IO	3.3V	
6	VCC3.3V	Power output	3.3V	

15-EDP (30pin/0.5mm FPC)

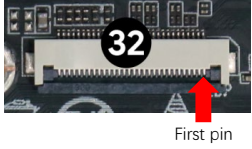
No.	Definition	Parameter	Level/V	Location
1	GND	Ground	0V	
2	EDP_TXD0N	EDP data 0-	1.2V	
3	EDP_TXD0P	EDP data 0+	1.2V	
4	GND	Ground	0V	
5	EDP_TXD1P	EDP data 1+	1.2V	
6	EDP_TXD1N	EDP data 1-	1.2V	
7	GND	GND	0V	
8	EDP_TX_AUXN	EDP_clock Output-	1.2V	
9	EDP_TX_AUXP	EDP_clock Output+	1.2V	
10	GND	Ground	0V	
11	EDP_TXD2N	EDP data 2-	1.2V	
12	EDP_TXD2P	EDP data 2+	1.2V	
13	GND	Ground	0V	

14	EDP_TXD3N	EDP data 3-	1.2V
15	EDP_TXD3P	EDP data 3+	1.2V
16	GND	Ground	0V
17	LCD PWM	LCD PWM	3.3V
18	LCD 3.3V	Optional Power 3.3V	3.3V
19	LCD 3.3V	Optional Power 3.3V	3.3V
20	RESET_N1EDP	RESET_N1EDP	3.3V
21	EDP ID	EDP ID	1,8V
22	LCD_PWREN	GPIO	3.3V
23	I2C1_SCL_TP	I2C1_SCL_TP data	3.3V
24	I2C1_SDA_TP	I2C1_SDA_TP data	3.3V
25	EDP_TP_INT	EDP_TP_INT	3.3V
26	EDP_TP_RESET	EDP_TP_RESET	3.3V
27	GND	Ground	3.3V
28	12V, 5V	Optional Power	12V, 5V
29	12V, 5V	Optional Power	12V, 5V
30	12V, 5V	Optional Power	12V, 5V

16-Camera MIPI (30pin/0.5mm)

No.	Definition	Parameter	Level/V	Location
1	VCC 2.8V	Optional Power	2.8V	
2	VCC 1.8V	Optional Power	1.8V	
3	VCC 1.2V	Optional Power	1.2V	
4	GND	Ground	0V	
5	GND	Ground	0V	
6	MIPI_MCLK	MIPI_MCLK	1.8V	
7	MIPI_CAM_PDN	GPIO	1.8V	
8	MIPI_CAM_PDN1	GPIO	1.8V	
9	MIPI_CAM0_RST1	GPIO	1.8V	
10	I2C_SCL	I2C_SCL	1.8V	
11	I2C_SDA	I2C_SDA	1.8V	
12	GND	Ground	0V	
13	MIPI_CSI_RX_CLK1N	MIPI CSI Clock input1-	1.2V	
14	MIPI_CSI_RX_CLK1P	MIPI CSI Clock input1+	1.2V	
15	GND	Ground	0V	
16	MIPI_CSI_RX_D3P	MIPI CSI Data entry 3+	1.2V	
17	MIPI_CSI_RX_D3N	MIPI CSI Data entry 3-	1.2V	
18	GND	Ground	0V	
19	MIPI_CSI_RX_D2P	MIPI CSI Data entry 2+	1.2V	
20	MIPI_CSI_RX_D2N	MIPI CSI Data entry 2-	1.2V	
21	GND	Ground	0V	
22	MIPI_CSI_RX_CLK0P	MIPI CSI Clock input0+	1.2V	
23	MIPI_CSI_RX_CLK0N	MIPI CSI Clock input0-	1.2V	
24	GND	Ground	0V	
25	MIPI_CSI_RX_D1P	MIPI CSI Clock input 1+	1.2V	
26	MIPI_CSI_RX_D1N	MIPI CSI Clock input 1-	1.2V	
27	GND	Ground	0V	
28	MIPI_CSI_RX_D0P	MIPI CSI Clock input 0+	1.2V	
29	MIPI_CSI_RX_D0N	MIPI CSI Clock input 0-	1.2V	
30	GND	Ground	0V	

Chapter 5 Precaution



01

Please ensure that the board is not charged when installing or assembling peripheral devices. When installing, be sure to wear anti-static tools such as static bracelets to prevent electrostatic discharge.



02

When connecting peripheral devices using wires, please make sure that the pin definitions of each device match the corresponding sockets on the motherboard to avoid short circuits caused by incorrect wire connections.



03

When fixing the motherboard with screws, please ensure that the board is evenly stressed to avoid PCB open circuit caused by board deformation.



04

When installing interfaces that allow for voltage selection, such as LVDS or eDP, please ensure that the selected voltage is consistent with the specifications of the screen.



05

When installing peripherals (USB, UART, IO, etc.), please pay attention to the IO level and current output capability of the peripherals.



06

When installing Serial connectors, please pay special attention to the matching of the IO level and the corresponding connections of TX, RX, 485-A, and 485-B.



07

The selection of the input power supply should be evaluated based on the total peripheral devices to determine whether the input voltage and total current can meet the requirements.



08

When designing the entire product, it is necessary to consider the height limitation and heat dissipation of the motherboard.